

VALENA™  
ELECTRICAL WIRING ACCESSORIES



PLUGGED INTO  
REAL LIFE

THE GLOBAL SPECIALIST IN ELECTRICAL  
AND DIGITAL BUILDING INFRASTRUCTURES



VALENA™

# MADE FOR CREATIVITY

With Cubist Alu or Brushed Alu Silver, discover new creative harmonies and sensory designs. These Valena finishes bring something special and a touch of French style to any interior. Embodying wealth and durability, Valena retains its original solid values, with classic finishes in contemporary designs.



Cubist Alu



Brushed Alu / Silver



Alu



Alu / Silver



Black / Silver



Dark Wood / Silver

VALENA™

# MADE FOR STYLE

With the new Baroque Mat Gold, Tanned Wood and Mat Gold finishes, update your décor with harmonious French style. Both sober and original, from classic to baroque, they introduce an air of refinement and elegance.



Baroque Mat Gold



Mat Gold / Gold



Tanned Wood



Ivory



Ivory / Gold

VALENA™

# MADE FOR FREEDOM

With classic White, Light Pearl and Pied de poule, Valena has expanded its range so you can create a harmonious new palette. White in all its splendour is used for new combinations and original patterns, giving more scope for creative design. Never before has white offered you so many different nuances and so much freedom.



Pied de poule



Light pearl

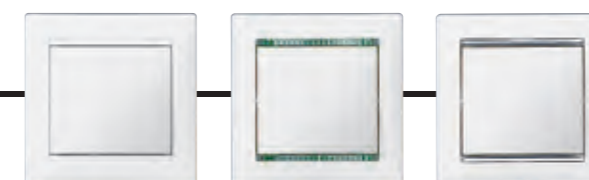

White    White / Crystal    White / Silver



CONTEMPORARY  
FINISHES  
TO SUIT ALL YOUR  
PROJECTS

ALUMINIUM



Cubist Alu



Brushed Alu / Silver



Alu



Alu / Silver



Black / Silver



Dark Wood / Silver

IVOIRE



Baroque Mat Gold



Mat Gold / Gold



Tanned Wood



Ivory



Ivory / Gold

BLANC



Pied de poule



Light pearl



White

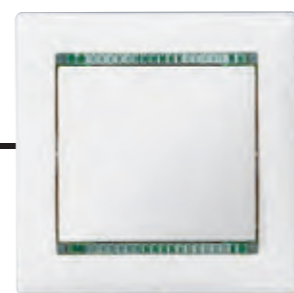

White / Crystal

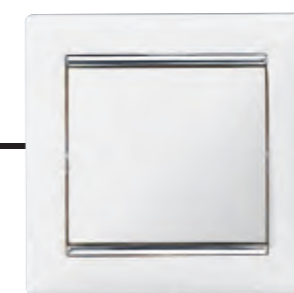

White / Silver

VALENA™

# A SAFE, RELIABLE MECHANISM PROVEN IN THE FIELD

VALENA CONTROL UNITS  
AND SOCKETS WITH  
SCREWLESS TERMINALS  
ARE QUICK AND  
EFFICIENT.  
THEY MAKE YOUR LIFE  
EASIER, IN COMPLETE  
SAFETY.

# THINKING GREEN? VALENA IS THE OBVIOUS CHOICE

UP TO  
**30%**

## ENERGY SAVINGS

Conforming to standard EN 15 193. Example based on an automatic switch with average daylight penetration.

### CONTROL UNITS WITH SCREWLESS TERMINALS

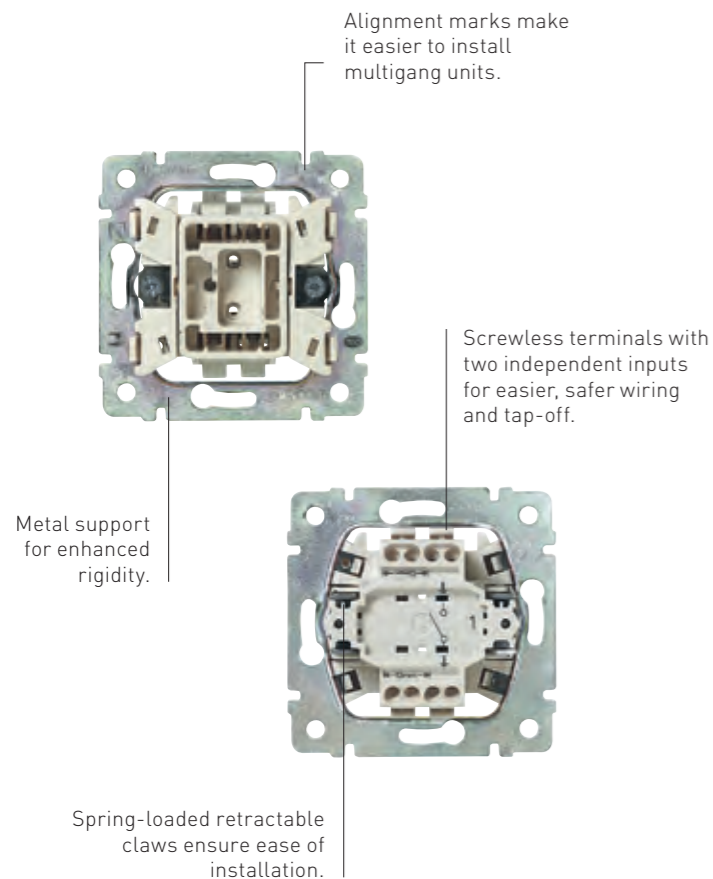

### SOCKETS WITH SCREWLESS TERMINALS

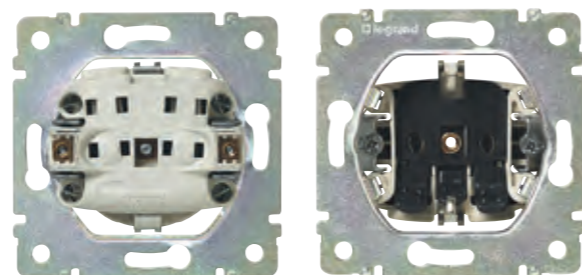

New screwless terminals for sockets.

## NEW PRODUCT



**Push control dimmer**  
For ON-OFF control and dimming lights: custom lighting to suit your wishes.



**Thermostat**  
For setting the temperature in each room and improving your well-being.



**Automatic switch**  
For switching lights on/off automatically for maximum energy savings.

VALENA™

# FEEL COMFORTABLE IN YOUR HOME



NO NEED TO CHOOSE BETWEEN STYLE, DESIGN, RELIABILITY OR SAFETY - VALENA BRINGS ALL THESE TO YOUR HOME.

## THE ASSURANCE OF BEING IN A SAFE PLACE



**Tuner with IP44 flap cover**  
For choosing your music even in damp rooms.



**IP44 socket outlet**  
For safe connections in damp places.



**Shuttered socket outlet**  
To keep all your family safe, even the little ones.

## THE PLEASURE OF SIMPLE COMMUNICATION

## THE SATISFACTION OF A COMFORTABLE INTERIOR



**Push control dimmer**  
For ON-OFF control and dimming lights: custom lighting to suit your wishes.



**Thermostat**  
For setting the temperature in each room and improving your well-being.



**Roller shutter**  
Roller shutter control.



**Dual USB charger socket**  
For charging mobile devices such as smartphones, tablets, MP3/MP4 players, etc.



**HDMI socket**  
For transmission of high-definition digital audio and video streams between a source (HD-DVD or Blu-Ray drive, etc) and a compatible receiver (plasma, LCD, etc).

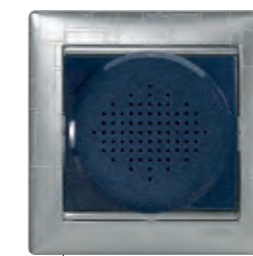

**Loudspeaker**  
For playing music in every room.



**RJ45-RJ11 socket**  
For easy, secure access to data, internet and telephone networks in the minimum space.

VALENA™

# CONNECTIVITY AND EFFICIENCY

FUNCTIONAL VALENA  
SOLUTIONS ADAPT  
SEAMLESSLY TO EACH  
OF YOUR PROJECTS.

## SOLUTIONS FOR ALL YOUR CONNECTIONS



**HD15 with jack**  
For VGA to UXGA  
connection of a screen,  
video projector, etc.  
and also the stereo  
connection from a  
portable source.



**Tamperproof  
socket**  
For connecting  
a particular  
device safely and  
exclusively.



**RJ45 and RJ11  
sockets**  
For easy, secure access to  
data, internet and telephone  
networks in the minimum  
space.

**Dual USB charger  
socket**  
For charging mobile  
devices such as  
smartphones, tablets,  
MP3/MP4 players, etc.

## SOLUTIONS FOR CREATING THE RIGHT ATMOSPHERE



**Double-pole  
switch**  
For extra safety whenever  
switching lights on and  
off.



**Automatic switch  
with override**  
For switching lights on/off  
automatically for maximum  
energy savings.



**Thermostat**  
For setting the  
temperature in each  
area individually.

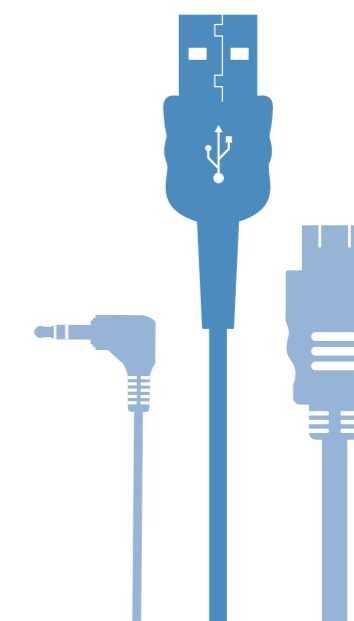



VALENA™

# PEACE OF MIND AT YOUR HOTEL

VALENA LIGHTING CONTROLS  
AND CONNECTIONS BRING  
BOTH AESTHETICS AND  
MODERNITY TO EVERY ROOM  
IN YOUR ESTABLISHMENT.

## COMFORT THAT COMBINES SAFETY



**Keycard switch**  
For lower energy  
consumption and  
lower bills.



**2-gang  
illuminated  
switch**  
For finding the switch  
easily, even in the dark.

## CONNECTIONS TO THE OUTSIDE WORLD



**Dual USB  
charger socket**  
For charging mobile  
devices such as  
smartphones, tablets,  
MP3/MP4 players, etc.



**RJ45 and RJ11  
sockets**  
For easy, secure  
access to data,  
internet and telephone  
networks in the  
minimum space.



**Double socket**  
For a maximum  
number of connections  
in the minimum space.

## PEACE OF MIND, EVEN IN THE BATHROOM



**IP44 socket  
outlet**  
For safe connections in  
damp places.



**Tuner with IP44  
flap cover**  
For choosing your  
music even in damp  
rooms.



**IP44 2-gang switch**  
For lighting controls in  
damp places.



7 743 06 + 7 703 11



7 744 06 + 7 704 20



7 701 05 + 7 703 31



7 742 13 + 7 704 91



7 741 01 + 7 741 51

Mechanisms supplied with cover plates, to be equipped with plates (p. 463-465)  
Screw or claw mounting

Pack	Cat.Nos	Switches 10 AX - 250 V~
		Automatic terminals
		<b>One-way switch</b>
10	7 743 01	● Ivory
10	7 744 01	○ White
10	7 701 01	● Brilliant Aluminium
		<b>Two-way switch</b>
10	7 743 06	● Ivory
10	7 744 06	○ White
10	7 701 06	● Brilliant Aluminium
		<b>Intermediate switch</b>
10	7 743 07	● Ivory
10	7 744 07	○ White
10	7 701 07	● Brilliant Aluminium
		<b>Illuminated switch</b> Supplied with 0.5 mA - 230 V green lamp Cat.No 7 758 97
10	7 743 10	● Ivory
10	7 744 10	○ White
10	7 701 10	● Brilliant Aluminium
		<b>Two-way switch with indicator</b> Supplied with 1 mA - 230 V orange lamp Cat.No 7 758 98
10	7 743 25	● Ivory
10	7 744 25	○ White
10	7 701 25	● Brilliant Aluminium
		<b>Illuminated two-way switch</b> Supplied with 0.5 mA - 230 V green lamp Cat.No 7 758 97
10	7 743 26	● Ivory
10	7 744 26	○ White
10	7 701 26	● Brilliant Aluminium
		<b>Illuminated intermediate switch</b> Supplied with 0.5 mA - 230 V green lamp Cat.No 7 758 97
10	7 743 48	● Ivory
10	7 744 48	○ White
10	7 701 48	● Brilliant Aluminium
		<b>2 gang one-way switch</b>
10	7 743 05	● Ivory
10	7 744 05	○ White
10	7 701 05	● Brilliant Aluminium
		<b>2 gang two-way switch</b>
10	7 743 08	● Ivory
10	7 744 08	○ White
10	7 701 08	● Brilliant Aluminium
		<b>2 gang two-way switch with one indicator</b> Supplied with 1 mA - 230 V orange lamp Cat.No 7 758 98
10	7 743 45	● Ivory
10	7 744 45	○ White
10	7 701 45	● Brilliant Aluminium
		<b>Illuminated 2 gang one-way switch</b> Supplied with 1 mA - 230 V green lamp Cat.No 7 758 97
10	7 743 28	● Ivory
10	7 744 28	○ White
10	7 701 28	● Brilliant Aluminium

Pack	Cat.Nos	Switches 10 AX - 250 V~ (continued)
		<b>2 gang one-way switch with two indicators</b> Supplied with 1 mA - 230 V orange lamp Cat.No 7 758 98
10	7 741 13	● Ivory
10	7 742 13	○ White
10	7 702 13	● Brilliant Aluminium
		<b>Illuminated 2 gang two-way switch</b> Supplied with 0.5 mA - 230 V green lamp Cat.No 7 758 97
10	7 741 12	● Ivory
10	7 742 12	○ White
10	7 702 12	● Brilliant Aluminium
		<b>Double pole switch</b>
10	7 743 02	● Ivory
10	7 744 02	○ White
10	7 701 02	● Brilliant Aluminium
		<b>Double pole switch with indicator</b> Supplied with 1 mA - 230 V orange lamp Cat.No 7 758 98
10	7 743 49	● Ivory
10	7 744 49	○ White
10	7 701 49	● Brilliant Aluminium
		<b>Switches 10 AX - 250 V~ - IP 44</b>
		Automatic terminals
		<b>One-way switch</b>
10	7 741 01	● Ivory
10	7 742 01	○ White
		<b>Two-way switch</b>
10	7 741 06	● Ivory
10	7 742 06	○ White
		<b>Intermediate switch</b>
10	7 741 97	● Ivory
10	7 700 97	○ White
		<b>2 gang two-way switch</b>
10	7 741 98	● Ivory
10	7 700 98	○ White
		<b>Double pole switch</b>
10	7 741 92	● Ivory
10	7 700 92	○ White

# Valena™

## switches (continued)



7 741 04 + 7 703 01



7 742 14 + 7 704 71

Mechanisms supplied with cover plates, to be equipped with plates (p. 463-465) - Screw or claw mounting

Pack	Cat.Nos	Switches 16 AX - 250 V~
		Automatic terminals
		<b>Two-way switch</b>
10	7 741 05	● Ivory
10	7 742 05	○ White
10	7 702 05	● Brilliant Aluminium
		<b>Illuminated two-way switch</b>
		Supplied with 0.5 mA - 230 V green lamp Cat.No 7 758 97
10	7 741 03	● Ivory
10	7 742 03	○ White
10	7 702 03	● Brilliant Aluminium
		<b>Double pole switch</b>
10	7 741 04	● Ivory
10	7 742 04	○ White
10	7 702 04	● Brilliant Aluminium
		<b>Double pole switch with indicator</b>
		Supplied with 1 mA - 230 V orange lamp Cat.No 7 758 98
10	7 741 14	● Ivory
10	7 742 14	○ White
10	7 702 14	● Brilliant Aluminium
		<b>3-pole switches 10 A - 400 V~</b>
		Automatic terminals
		<b>For fluorescent tubes</b>
10	7 743 03	● Ivory
10	7 744 03	○ White
10	7 701 03	● Brilliant Aluminium

# Valena™

## push-buttons



7 743 12 + 7 743 51



7 701 13 + 7 703 51



7 744 19  
+ 7 744 51

Mechanisms supplied with cover plates, to be equipped with plates (p. 463-465) - Screw or claw mounting

Pack	Cat.Nos	Push-buttons 10 A - 250 V~
		Automatic terminals
		<b>Push-button</b>
10	7 743 11	● Ivory
10	7 744 11	○ White
10	7 701 11	● Brilliant Aluminium
		<b>Push-button with lamp symbol</b>
10	7 743 12	● Ivory
10	7 744 12	○ White
10	7 701 12	● Brilliant Aluminium
		<b>Push-button with bell symbol</b>
10	7 741 16	● Ivory
10	7 742 16	○ White
10	7 702 16	● Brilliant Aluminium
		<b>Illuminated push-button with lamp symbol</b>
		Supplied with 1 mA - 230 V green lamp Cat.No 7 758 90
10	7 743 13	● Ivory
10	7 744 13	○ White
10	7 701 13	● Brilliant Aluminium
		<b>Illuminated push-button with bell symbol</b>
		Supplied with 1 mA - 230 V green lamp Cat.No 7 758 90
10	7 741 15	● Ivory
10	7 742 15	○ White
10	7 702 15	● Brilliant Aluminium
		<b>Double changeover push-button</b>
1	7 741 18	● Ivory
1	7 742 18	○ White
1	7 702 18	● Brilliant Aluminium
		<b>Changeover push-button for pull cord control</b>
1	7 743 19	● Ivory
1	7 744 19	○ White
1	7 701 19	● Brilliant Aluminium
		<b>Push-buttons 10 A - 250 V~ - IP 44</b>
		<b>Push-button with bell symbol</b>
10	7 741 99	● Ivory
10	7 700 99	○ White
		<b>Push-buttons 10 A - 12 V~</b>
		Automatic terminals
		<b>Illuminated push-button with bell symbol</b>
		Supplied with 15 mA - 8-12 V green lamp Cat.No 7 758 99
10	7 743 15	● Ivory
10	7 744 15	○ White
10	7 701 15	● Brilliant Aluminium
		<b>Illuminated push-button with label-holder</b>
		Supplied with 15 mA - 8-12 V green lamp Cat.No 7 758 99
10	7 741 17	● Ivory
10	7 742 17	○ White
10	7 702 17	● Brilliant Aluminium
		<b>Accessory</b>
10	0 898 05	Pull-cord accessory 1.5 m length



7 700 89 + 7 744 51



7 700 74 + 7 744 61

Mechanisms supplied with cover plates, to be equipped with plates (p. 463-465) - Screw or claw mounting

Pack	Cat.Nos	Automatic switches with movement detector
		230 V~ - 50/60 Hz Luminosity threshold: 3 to 1000 lux
		<b>Standard</b> 60-300 W for incandescent and halogen lamps 230 V~ Temporization: 6 seconds to 6 min. Can replace a switch without additional wiring Detection angle: 130°
1	7 741 28	● Ivory
1	7 742 28	○ White
1	7 702 28	● Brilliant Aluminium
		<b>With override, with neutral</b> 1000 W for incandescent and halogen lamps 230 V~ 500 VA ELV lamps with electronic or ferromagnetic transformers, fluorescent tubes and compact lamps 100 VA fans Temporization: 1 second to 16 min Detection angle: 180° Can be remotely controlled via non-illuminated push-button
1	7 741 89	● Ivory
1	7 700 89	○ White
1	7 702 89	● Brilliant Aluminium
		<b>Dimmers 230 V~ - 50 Hz</b>
		<b>Rotary dimmer</b> Push to On/Off function Rotate for light level adjustment 100-1000 W for incandescent and halogen lamps 230 V~ 1000 VA ELV lamps with ferromagnetic transformers
1	7 741 60	● Ivory
1	7 700 60	○ White
1	7 702 60	● Brilliant Aluminium
		<b>Rotary adjustment and control</b> 40-400 W for incandescent and halogen lamps 230 V~ 40-400 VA ELV lamps with ferromagnetic transformers
1	7 741 61	● Ivory
1	7 700 61	○ White
1	7 702 61	● Brilliant Aluminium
		<b>Push-button dimmer - 40-400 W</b> With an On/Off button and a separate + / - button for dimming 40-400 W for incandescent and halogen lamps 230 V~ 40-400 VA ELV halogen lamps with electronic and ferromagnetic transformers Can be remotely controlled via non-illuminated push-button or two-way switch
1	7 741 62	● Ivory
1	7 700 62	○ White
1	7 702 62	● Brilliant Aluminium
		<b>Push-button dimmer - 40-600 W</b> With an On/Off button and a separate + / - button for dimming 40-600 W for incandescent and halogen lamps 230 V~ 40-600 VA ELV halogen lamps with ferromagnetic transformers
1	7 741 74	● Ivory
1	7 700 74	○ White
1	7 702 74	● Brilliant Aluminium



7 743 04 + 7 703 11



7 741 35 + 7 700 20



7 741 26 + 7 743 51

Mechanisms supplied with cover plates, to be equipped with plates (p. 463-465) - Screw or claw mounting

Pack	Cat.Nos	Roller blinds control 10 A - 250 V~
		Automatic terminals
		<b>Switch with mechanical interlock</b>
1	7 743 04	● Ivory
1	7 744 04	○ White
1	7 701 04	● Brilliant Aluminium
		<b>Push-button with electrical interlock</b>
1	7 743 14	● Ivory
1	7 744 14	○ White
1	7 701 14	● Brilliant Aluminium
		<b>Keycards for hotel rooms</b> For energizing a circuit by inserting a card Example of use: hotel room power supply only when the guest is present 230 V~ - 50/60 Hz
		<b>Standard</b> Compatible with a smart card for hotel room max. width 54 mm
10	7 741 34	● Ivory
10	7 742 34	○ White
10	7 702 34	● Brilliant Aluminium
		<b>With time delay</b> Compatible with a smart card for hotel room max. width 54 mm or a key fob Cat.No 0 898 06 (p. 504) Aprox 30 sec. after card removal
1	7 741 35	● Ivory
1	7 742 35	○ White
1	7 702 35	● Brilliant Aluminium
		<b>Thermostats</b>
		<b>Standard</b> NO/NC contact to control heating or air-conditioning
1	7 741 26	● Ivory
1	7 742 26	○ White
1	7 702 26	● Brilliant Aluminium
		<b>Comfort with switch</b> Comfort/reduce, manual or automatic with auxiliary input 230 V~
1	7 741 27	● Ivory
1	7 742 27	○ White
1	7 702 27	● Brilliant Aluminium
		<b>For floor heating system</b> Comfort mode reduced with auxiliary input 230 V~ Supplied with floor sensor, length 20 m
1	7 741 91	● Ivory
1	7 700 91	○ White
1	7 702 91	● Brilliant Aluminium
		<b>Thermostat probe</b> Length 20 m
1	7 700 93	● Brilliant Aluminium

# Valena™

## television sockets



7 701 36 + 7 703 91



7 744 32 + 7 744 51



7 743 29 + 7 703 01



7 743 42

Mechanisms supplied with cover plates, to be equipped with plates (p. 463-465)  
Screw or claw mounting

For Hertzian and satellite installation (with individual demodulator)

DTT and HDTV compatible. Shielded sockets

TV: male connector (Ø9.5 mm)

R: female connector (Ø9.5 mm)

SAT: "F" type connector

Recommended coaxial cable: 17/19 VATC

Pack	Cat.Nos	TV-R-SAT sockets
		TV: 5-68/120-862 MHz R: 87.5-108 MHz SAT: 550-2400 MHz
		<b>Star socket - 1.5 dB</b>
10	7 743 35	● Ivory
10	7 744 35	○ White
10	7 701 35	● Brilliant Aluminium
		<b>Terminal socket - 10 dB</b>
10	7 743 36	● Ivory
10	7 744 36	○ White
10	7 701 36	● Brilliant Aluminium
		<b>Passthrough socket - 14 dB</b>
10	7 743 37	● Ivory
10	7 744 37	○ White
10	7 701 37	● Brilliant Aluminium
		<b>TV-R-SAT 2 cables - 1.5 dB</b>
		Possible to add satellite on existing installation without connection, just need a second cable to the socket
		○ White
10	7 704 10	● Ivory
10	7 741 10	● Brilliant Aluminium
10	7 702 10	
		<b>TV-R central plates</b>
		30 mm with screw for adaptation to local manufacturers such as DX Contera, Televes and Hirschmann
10	7 743 42	● Ivory
10	7 744 42	○ White
10	7 701 42	● Brilliant Aluminium

Pack	Cat.Nos	TV-R sockets
		TV: 5-68/120-862 MHz R: 87.5-108 MHz
		<b>Star socket - 1.5 dB</b>
10	7 743 32	● Ivory
10	7 744 32	○ White
10	7 701 32	● Brilliant Aluminium
		<b>Terminal socket - 10 dB</b>
10	7 743 33	● Ivory
10	7 744 33	○ White
10	7 701 33	● Brilliant Aluminium
		<b>Passthrough socket - 14 dB</b>
10	7 743 34	● Ivory
10	7 744 34	○ White
10	7 701 34	● Brilliant Aluminium
		<b>TV sockets</b>
		TV: 0-2400 MHz
		<b>Star socket - 1.5 dB</b>
10	7 743 29	● Ivory
10	7 744 29	○ White
10	7 701 29	● Brilliant Aluminium
		<b>Terminal socket - 10 dB</b>
10	7 743 30	● Ivory
10	7 744 30	○ White
10	7 701 30	● Brilliant Aluminium
		<b>Passthrough socket - 14 dB</b>
10	7 743 31	● Ivory
10	7 744 31	○ White
10	7 701 31	● Brilliant Aluminium

# Valena™

## data sockets



7 741 44 + 7 743 51



7 702 39 + 7 703 71

Mechanisms supplied with cover plates, to be equipped with plates (p. 463-465) - Screw or claw mounting  
Fast connection sockets – no tool required  
Contacts marked with double colour codes

Pack	Cat.Nos	Data sockets Cat. 6
10	7 741 46	<b>RJ 45 UTP - 1 outlet</b> <ul style="list-style-type: none"> <li>● Ivory</li> <li>● Ivory - without claws</li> <li>○ White</li> <li>○ White - without claws</li> <li>● Brilliant Aluminium</li> <li>● Brilliant Aluminium - without claws</li> </ul>
10	7 741 42	
10	7 742 46	
10	7 742 42	
10	7 702 46	
10	7 702 42	
10	7 741 47	<b>RJ 45 UTP - 2 outlets</b> <ul style="list-style-type: none"> <li>● Ivory</li> <li>● Ivory - without claws</li> <li>○ White</li> <li>○ White - without claws</li> <li>● Brilliant Aluminium</li> <li>● Brilliant Aluminium - without claws</li> </ul>
10	7 741 43	
10	7 742 47	
10	7 742 43	
10	7 702 47	
10	7 702 43	
10	7 741 32	<b>RJ 45 FTP - 1 outlet - without claws</b> <ul style="list-style-type: none"> <li>● Ivory</li> <li>○ White</li> <li>● Brilliant Aluminium</li> </ul>
10	7 742 32	
10	7 702 32	
10	7 741 33	<b>RJ 45 FTP - 2 outlets - without claws</b> <ul style="list-style-type: none"> <li>● Ivory</li> <li>○ White</li> <li>● Brilliant Aluminium</li> </ul>
10	7 742 33	
10	7 702 33	
10	7 741 44	<b>RJ 45 STP - 1 outlet - without claws</b> <ul style="list-style-type: none"> <li>● Ivory</li> <li>○ White</li> <li>● Brilliant Aluminium</li> </ul>
10	7 742 44	
10	7 702 44	
10	7 741 45	<b>RJ 45 STP - 2 outlets - without claws</b> <ul style="list-style-type: none"> <li>● Ivory</li> <li>○ White</li> <li>● Brilliant Aluminium</li> </ul>
10	7 742 45	
10	7 702 45	

Pack	Cat.Nos	Data sockets Cat. 5e
10	7 741 30	<b>RJ 45 UTP - 1 outlet</b> <ul style="list-style-type: none"> <li>● Ivory</li> <li>● Ivory - without claws</li> <li>○ White</li> <li>○ White - without claws</li> <li>● Brilliant Aluminium</li> <li>● Brilliant Aluminium - without claws</li> </ul>
10	7 741 38	
10	7 742 30	
10	7 742 38	
10	7 702 30	
10	7 702 38	
10	7 741 31	<b>RJ 45 UTP - 2 outlets</b> <ul style="list-style-type: none"> <li>● Ivory</li> <li>● Ivory - without claws</li> <li>○ White</li> <li>○ White - without claws</li> <li>● Brilliant Aluminium</li> <li>● Brilliant Aluminium - without claws</li> </ul>
10	7 741 39	
10	7 742 31	
10	7 742 39	
10	7 702 31	
10	7 702 39	

# Valena™

## telephone sockets



7 744 38 + 7 744 51



7 702 80 + 7 703 31

Mechanisms supplied with cover plates, to be equipped with plates (p. 463-465) - Screw or claw mounting

Pack	Cat.Nos	Telephone sockets
		Sockets equipped with quick-fit 1/4 turn self-stripping connectors linkage
10	7 743 38	<b>RJ 11 - 4 contacts - 1 outlet</b> <ul style="list-style-type: none"> <li>● Ivory</li> <li>○ White</li> <li>● Brilliant Aluminium</li> </ul>
10	7 744 38	
10	7 701 38	
10	7 743 39	<b>RJ 11 - 4 contacts - 2 outlets</b> <ul style="list-style-type: none"> <li>● Ivory</li> <li>○ White</li> <li>● Brilliant Aluminium</li> </ul>
10	7 744 39	
10	7 701 39	
1	7 743 41	<b>RJ 45 - ISDN / Internet - 8 contacts</b> 1 output <ul style="list-style-type: none"> <li>● Ivory</li> <li>○ White</li> <li>● Brilliant Aluminium</li> </ul>
1	7 744 41	
1	7 701 41	
10	7 741 80	<b>Twin socket RJ 45 Cat 6 UTP + RJ 11</b> Without claws <ul style="list-style-type: none"> <li>● Ivory</li> <li>○ White</li> <li>● Brilliant Aluminium</li> </ul>
10	7 700 80	
10	7 702 80	

# Valena™

## audio/video sockets



7 743 24 + 7 743 51



7 702 82 + 7 703 51

Mechanisms supplied with cover plates, to be equipped with plates (p. 463-465) - Screw or claw mounting

Pack	Cat.Nos	<b>Loudspeaker sockets</b>
		Equipped with DIN 41 529 standard connectors For 0.75 to 5 mm <sup>2</sup> cables Screw terminals
		<b>Single loudspeaker socket</b>
10	7 741 23	● Ivory
10	7 742 23	○ White
10	7 702 23	● Brilliant Aluminium
		<b>Double loudspeaker socket</b>
10	7 743 24	● Ivory
10	7 744 24	○ White
10	7 701 24	● Brilliant Aluminium
		<b>Audio and video sockets</b>
		<b>Audio/video socket HDMI</b>
		HDMI audio/video type A socket Used to transmit High-definition digital audio/video streams between a source (HD-DVD or Blu-Ray drive, games console, computer, etc) and a compatible receiver (TV, video projector)
1	7 741 85	● Ivory
1	7 700 85	○ White
1	7 702 85	● Brilliant Aluminium
		<b>Video socket HD 15</b>
		For the VGA, XGA or VESA connection of a PC monitor, TV, video projector
1	7 741 83	● Ivory
1	7 700 83	○ White
1	7 702 83	● Brilliant Aluminium
		<b>Triple RCA socket</b>
		For the composite video and stereo audio connection of any amplifier, DVD drive, VCR type peripheral
1	7 741 84	● Ivory
1	7 700 84	○ White
1	7 702 84	● Brilliant Aluminium
		<b>HD 15 + 3.5 mm Jack sockets</b>
1	7 741 82	● Ivory
1	7 700 82	○ White
1	7 702 82	● Brilliant Aluminium

# Valena™

## equipment for audio/video sockets



0 517 20



0 517 22



0 779 30

Pack	Cat.Nos	<b>Equipment cords</b>
		For connecting a socket to a terminal
		<b>HDMI 1.4 cord</b>
1	0 517 20	Length 10 m For connecting an HDMI socket to the audio/video terminal (plasma screen, DVD drive, Home Cinema, games console, etc) For use at more than 10 m, use the HDMI Booster Cat.No 0 779 30
		<b>HD 15 + 3.5 mm Jack cord</b>
1	0 517 22	Length 2 m For connecting an HD 15 video socket and a 3.5 mm audio jack to a terminal (PC, video projector)
		<b>HDMI booster</b>
1	0 779 30	Used to extend an HDMI connection Consists of 2 female connectors and used as an addition to the HDMI cord (for example cord Cat.No 0 517 20) Does not need an external power supply
		<b>Cables</b>
		For connecting 2 sockets
		<b>HDMI cable</b>
1	0 327 80	Length 20 m For connecting HDMI sockets at a distance of up to 10 m
		<b>VGA cable</b>
1	0 327 81	Length 20 m For connecting full pin HD 15 sockets at a distance of up to 20 m



7 743 16 + 7 743 51



7 744 21 + 7 744 51



7 743 27 + 7 701 51



7 702 11 + 7 703 71

Mechanisms supplied with cover plates, to be equipped with plates (p. 498-499)  
 Screw or claw mounting  
 IP 2 protection index  
 Terminals: 2.5 mm<sup>2</sup>

Pack	Cat.Nos	2P socket outlets 10/16 A - 250 V~
10	7 743 16	<b>Screw terminals</b> ● Ivory ○ White ● Brilliant Aluminium
10	7 744 16	
10	7 701 16	
		<b>German standard socket outlets 10/16 A - 250 V~</b>
		<b>2P+E - automatic terminals with shutters</b>
10	7 741 22	● Ivory ○ White ● Brilliant Aluminium
10	7 742 22	
10	7 702 11	
		<b>2P+E - screw terminals</b>
10	7 743 20	● Ivory ○ White ● Brilliant Aluminium
10	7 744 20	
10	7 701 20	
		<b>2P+E with shutters for child protection - screw terminals</b>
10	7 743 21	● Ivory ○ White ● Brilliant Aluminium
10	7 744 21	
10	7 701 21	
		<b>2P+E with flap - screw terminals</b>
10	7 743 22	● Ivory ○ White ● Brilliant Aluminium
10	7 744 22	
10	7 701 22	
		<b>2P+E with mechanical ejecting system for plug - screw terminals</b>
5	7 743 95	● Ivory ○ White ● Brilliant Aluminium
5	7 743 94	
5	7 701 94	
		<b>2P+E with coloured cover plate - screw terminals</b>
10	7 743 27	● Red with tamperproof
		● Green
10	7 743 72	● Green
		● Orange
10	7 743 73	● Orange
		<b>2P+E supplied complete</b> With cover plate and plate
10	7 743 23	● Ivory - screw terminals ● Ivory - automatic terminals ○ White - screw terminals ○ White - automatic terminals ● Brilliant Aluminium - screw terminals ● Brilliant Aluminium - automatic terminals
10	7 741 19	
10	7 744 23	
10	7 742 19	
10	7 701 23	
10	7 702 19	

Pack	Cat.Nos	German standard socket outlets 16 A - 250 V~ - IP 44
		<b>2P+E with flap and shutters for child protection - screw terminals</b>
10	7 741 20	● Ivory ○ White
10	7 742 20	
		<b>2P+E key protected with flap - screw terminals</b>
1	7 742 60	○ White Delivered with accessory Cat.No 7 759 99
		<b>French standard socket outlets 10/16 A - 250 V~</b>
		<b>2P+E - screw terminals</b>
10	7 743 98	● Ivory ○ White ● Brilliant Aluminium
10	7 743 96	
10	7 701 96	
		<b>2P+E with shutters for child protection - screw terminals</b>
10	7 743 99	● Ivory ○ White ● Brilliant Aluminium
10	7 743 97	
10	7 701 97	
		<b>2P+E with red cover plate - screw terminals</b>
10	7 700 90	● Red with tamperproof
		<b>French standard socket outlets 16 A - 250 V~ - IP 44</b>
		<b>2P+E with flap and shutters for child protection - screw terminals</b>
10	7 741 21	● Ivory ○ White
10	7 742 21	



# Valena™

## USB chargers



# Valena™

## USB chargers



7 704 70 + 7 744 51



0 803 99

Pack	Cat.Nos	USB chargers, 2 USB 1500 mA
1	7 704 70	<p>Conforms to standard IEC 62684-2011-01 For charging mobile phones, tablet PCs, smartphones, MP3 and MP4 players quickly Frees up a socket recess Consumption in passive mode &lt; 0.1 W CLASS II SELV Conforms to the EEC directive on harmonisation of the charging standard for portable terminals and the reduction of mobile phone chargers For installation in flush-mounting box depth 40 mm minimum Tap-off connection possible on 2P+E socket Supplied cordless</p> <p><b>N</b></p> <ul style="list-style-type: none"> <li>○ White</li> <li>● Ivory</li> <li>● Brilliant Aluminium</li> </ul>
1	7 741 70	
1	7 702 70	

10	0 803 99	<p><b>Support for smartphone</b></p> <p>Supplied with 60 cm USB/micro USB retractable cord For charging and synchronisation with PC Resistance &gt; 7500 operations Fixing using screws or adhesive on all surfaces Has a non-slip coating to prevent phones falling off The phone's screen can be seen while charging</p>
----	----------	--

### Application examples

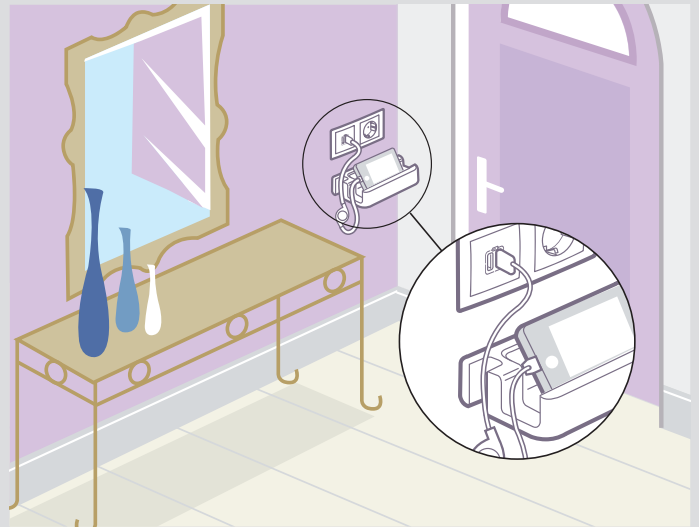

Installed in the hall, the USB charger provides quick, easy to find, always available charging as soon as you get home (no more lost chargers cluttering up the house)



Installed beside the bed, the USB charger powers the mobile during the night without using a 2P+E socket

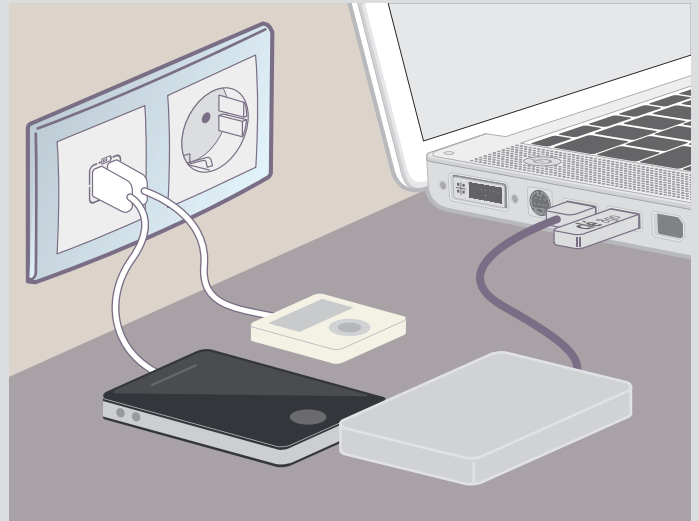

Installed near the PC, the USB charger frees up the USB ports on my terminal and avoids me having to start it up

### Average charge time for a smartphone with a 1500 mA charger

Brand	Smartphone	Average charge time 80 %	Average charge time 100 %
RIM	Blackberry Torch 9810	01h01	01h23
Apple	iPhone 3GS	01h04	02h07
Apple	iPhone 4S	01h14	01h56
Apple	iPhone 5	01h14	02h20
Motorola	Defy - MB525 - Jordan	01h13	01h47
Nokia	Lumia 800 - Sea Ray	01h39	02h33
Samsung	Galaxy S III - 19300	01h47	02h43
Samsung	Galaxy S IV	02h00	02h59
Sony	XPERIA S - LT26i - Arc HD Nozomi	01h20	02h05
		average < 1h15	average < 2h

# Valena™

complete sockets outlets



7 743 71



2 x 7 742 02 + 7 742 07

Mechanisms supplied with cover plates  
Screw or claw mounting

Pack	Cat.Nos	
		<b>German standard double socket outlets 16 A - 250 V~</b>
		Flush-mounting in 1 gang Ø60 mm boxes Supplied complete with cover plate and plate
5	7 743 70	<b>2 x 2P+E - screw terminals</b>
5	7 744 00	● Ivory
5	7 701 00	○ White
		● Brilliant Aluminium
5	7 743 71	<b>2 x 2P+E with shutters for child protection</b>
5	7 744 27	● Ivory - screw terminals
5	7 742 48	○ White - screw terminals
5	7 701 27	○ White - automatic terminals
		● Brilliant Aluminium - screw terminals
		<b>French standard double socket outlets 16 A - 250 V~</b>
		Flush-mounting in 1 gang Ø60 mm boxes Supplied complete with cover plate and plate
5	7 743 92	<b>2 x 2P+E - screw terminals</b>
5	7 743 90	● Ivory
5	7 702 90	○ White
		● Brilliant Aluminium
5	7 743 93	<b>2 x 2P+E with shutters for child protection</b>
5	7 743 91	● Ivory
5	7 701 91	○ White
		● Brilliant Aluminium
		<b>Nordic countries socket outlets 16 A - 250 V~</b>
5	7 742 02	<b>2 x 2P+E with shutters for child protection - automatic terminals</b>
		○ White
5	7 742 07	<b>Special plate</b> 2 gang
10	7 742 10	<b>Special adaptor</b> For single sockets, RJ 45 sockets and TV-R-SAT sockets

# Valena™

accessories



7 743 47 + 7 743 51



7 744 50

Pack	Cat.Nos	
		<b>Cable outlets</b>
10	7 743 47	● Ivory
10	7 744 47	○ White
10	7 701 47	● Brilliant Aluminium
		<b>Blanking plates</b>
10	7 743 46	● Ivory
10	7 744 46	○ White
10	7 701 46	● Brilliant Aluminium
		<b>Universal plates 46.5 mm</b>
10	7 743 80	● Ivory
10	7 744 80	○ White
10	7 701 80	● Brilliant Aluminium
		<b>Weatherproof plates - IP 44</b>
		Compatible with any non IP 44 mechanisms, for 1 gang installation only IP 44 plate with flap
10	7 743 50	● Ivory
10	7 744 50	○ White
10	7 701 50	● Brilliant Aluminium
		<b>Accessory</b>
1	7 759 99	<b>Key protection for German standard socket outlet</b> Accessory for key protection
		<b>Mounting accessories</b>
		<b>Surface-mounting box</b>
10	7 761 31	● Ivory
10	7 761 81	○ White
		<b>Accessory for adapting cables and tubes</b>
10	7 761 34	● Ivory
10	7 761 84	○ White
		<b>Combination accessory</b> For multiple vertical assemblies of surface boxes
10	7 761 35	● Ivory
10	7 761 85	○ White
		<b>Replacement lamps</b>
10	7 758 97	0.5 mA - 230 V - Green
10	7 758 98	1 mA - 230 V - Orange
10	7 758 99	15 mA - 12 V~ - Green
10	7 758 90	1 mA - 230 V - Green

# Valena™

## sound diffusion



7 700 70 + 7700 69 + 7701 52













7 741 67 + 7 741 68 + 7 743 52

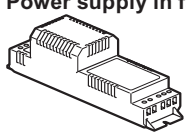

7 700 71 + 7 701 51

Mechanisms supplied with cover plates, to be equipped with plates (p. 463-465)  
Screw or claw mounting

Pack	Cat.Nos	Single zone sound diffusion	Pack	Cat.Nos	Multi-zone sound diffusion (continued)
1	7 700 69	<b>Tuner</b>  Power supply 15 V <sub>DC</sub> Manual or automatic selection of stations 10-station memory Integrated aerial (adjustable reception sensitivity) On/off control Volume control Equipped with an auxiliary input for connecting an MP3 player or Discman (3.5 mm Jack socket), cord not supplied Compatible with 4/8 or 16 Ω Stereo or mono output Grey cover plate			<b>Tuner extension and intercom</b> Used together with the local control and with no additional wiring, the extension can be used to distribute radio on one control unit Automatic or manual search Intercom function (call to one room or a set of rooms, call takes priority over music distribution) Baby monitoring function Simplified access to local control functions via dedicated switches  <ul style="list-style-type: none"> <li>● Ivory</li> <li>○ White</li> <li>● Brilliant Aluminium</li> </ul>
1	7 700 70	<b>Power supply for tuner with integrated loudspeaker</b>  Used together with tuner Cat.No 7 700 69, it can distribute radio or the music source Loudspeaker power 1 W - 16 Ω Grey cover plate			<b>Loudspeakers</b> <b>Flush-mounting loudspeaker</b> Max. power 2 W - 16 Ω - 2"  <ul style="list-style-type: none"> <li>● Ivory</li> <li>○ White</li> <li>● Grey</li> </ul>
1	0 673 22	<b>Power supply in false ceiling for tuner</b>  Power supply 230 V <sub>AC</sub> Output 15 V <sub>DC</sub> - 3.5 W For use in Plexo box Cat.No 0 920 52			<b>False ceiling mounting spot loudspeaker</b>  White Depth 27 mm Ø hole: 65 mm Visible depth: 11 mm Power: 2 W - 16 Ω - 2" Equipped with clips for attachment Use a Ø65 mm crown saw to cut the hole
		<b>Multi-zone sound diffusion</b> <b>Source input with modular power supply</b> Used to connect the main music source (Hi-Fi, computer, etc.) via Ø3.5 mm jack socket (cord not supplied) The source input powers local controls Cat.No 7 741 67 to distribute music in the rooms of a house (1 local control per room) Supplied with 15 V - 60 W modular power supply, size 4.5 DIN modules  <ul style="list-style-type: none"> <li>● Ivory</li> <li>○ White</li> <li>● Brilliant Aluminium</li> </ul>			<b>False ceiling mounting invisible loudspeaker</b>  For multi-zone sound distribution Can be connected with the 15 V - 60 W power supply supplied with source input Max. power 8 W Depth: 98 mm Supplied with adhesive and gluing template
1	7 741 66		1	0 673 30	<b>Standard flush-mounting loudspeaker</b>  White Power: 100 W - 8 Ω - 6.5" Ø hole: 198 mm Depth: 85 mm
1	7 700 66				
1	7 702 66				
		<b>Local control</b> Equipped with an LCD screen, used to select the music source: main (Hi-Fi) or local (e.g.: MP3 player) via cord with Ø3.5 mm jack (not supplied) Stereo output 2 x 1.5 W Volume, balance, bass/treble and loudness controls Time display Integrated alarm clock function (by beep or music) General call function from all local controls with answer possible from the person called (microphone integrated in the product) Compatible with 4-8 or 16 Ω  <ul style="list-style-type: none"> <li>● Ivory</li> <li>○ White</li> <li>● Brilliant Aluminium</li> </ul>			
1	7 741 67				
1	7 700 67				
1	7 702 67				

**Diffusion of a music source in one room in a house (for example the kitchen, bathroom, etc.)**

With spot loudspeakers Cat.No 0 673 27 and power supply Cat.No 7 700 69 (stereo)

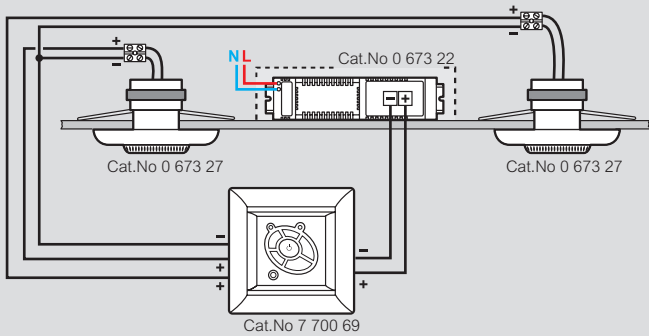

With power supply for tuner Cat.No 7 700 69 + integrated loudspeaker Cat.No 7 700 70 (mono)

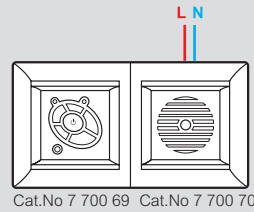

**Diffusion of a music source in all the rooms in a house**

Diffusion of the main source or independent auxiliary (MP3 player) via local control Cat.Nos 7 741 67/7 700 67/7 702 67

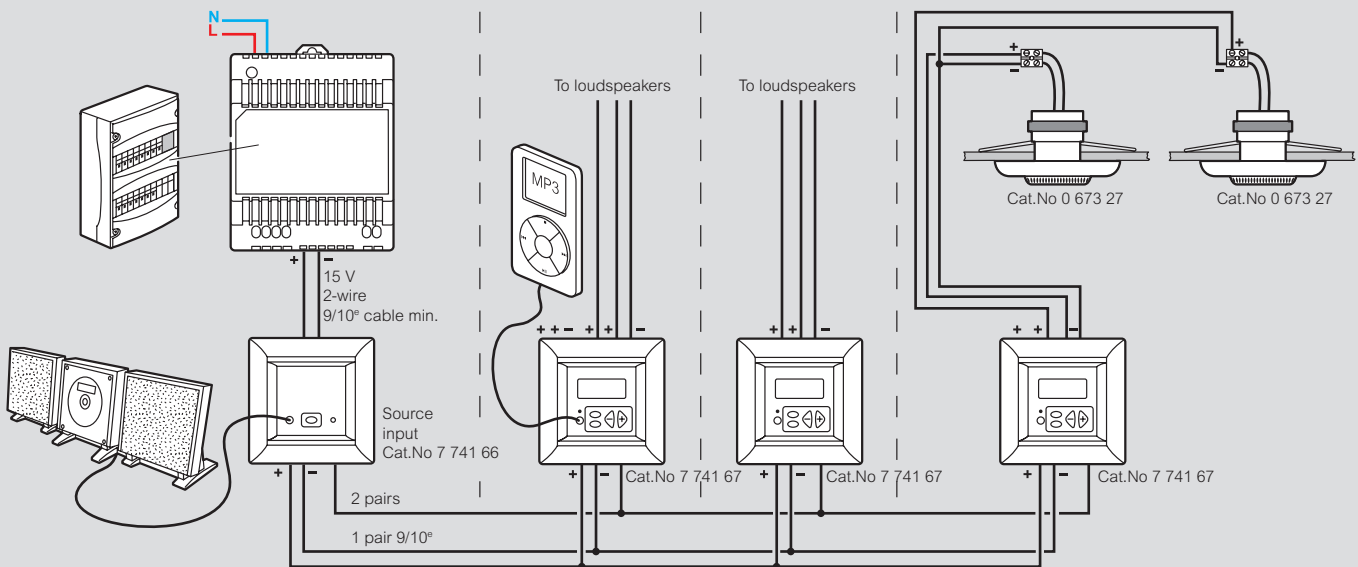

Diffusion of the main source, the auxiliary (MP3 player) or independent FM radio, via local control Cat.Nos 7 741 67/7 700 67/7 702 67 and tuner extension Cat.Nos 7 741 68/7 700 68/7 702 68

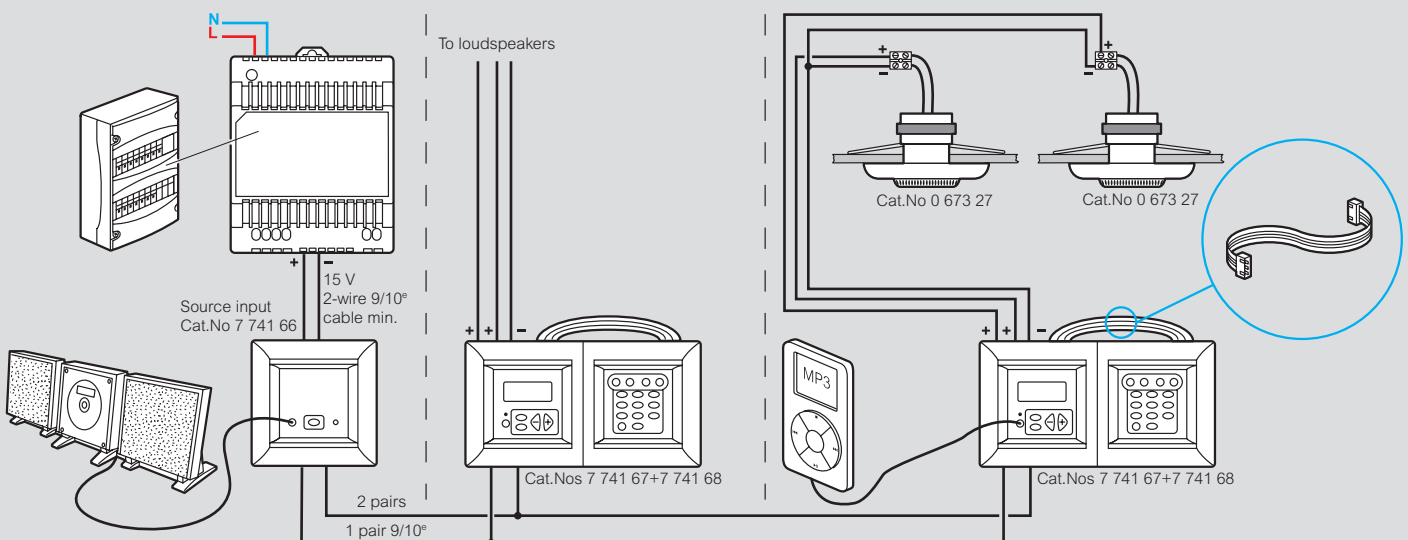



# VALENA™

## Made in creativity, design and freedom



Cubist Alu



Brushed Alu/Silver



Alu



Alu/Silver

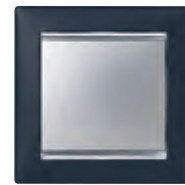

Black/Silver



Dark Wood / Silver



Pied de Poule



Light Pearl



White



White / Silver

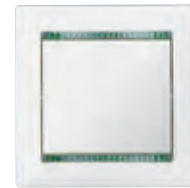

White / Crystal



Baroque Matt Gold



Matt Gold



Tanned Wood



Ivory



Ivory/Gold

## Upgrade your current installation



You can replace your existing white or ivory cover plate by an aluminium cover plate



Remove cover plate and replace by aluminium cover plate

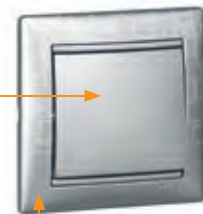

Remove plate and replace by any Valena finish plate

## Reversible 4 and 5 gangs plates

Can be transformed in vertical or horizontal plate by rotation of internal trim

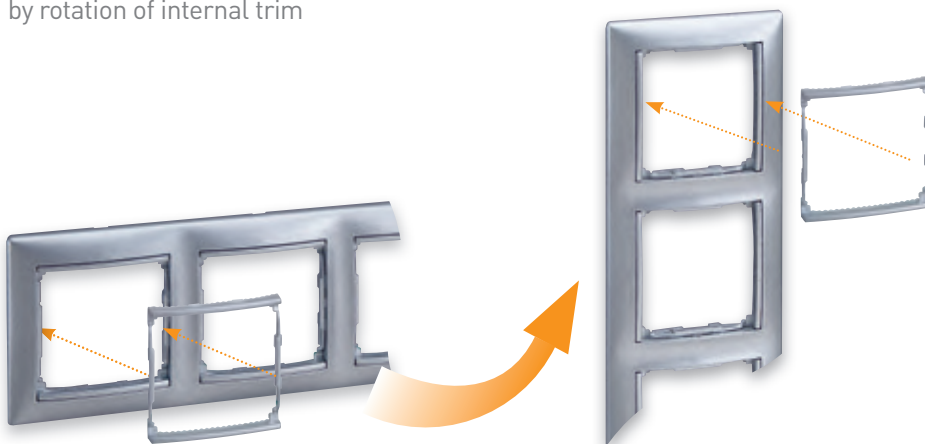

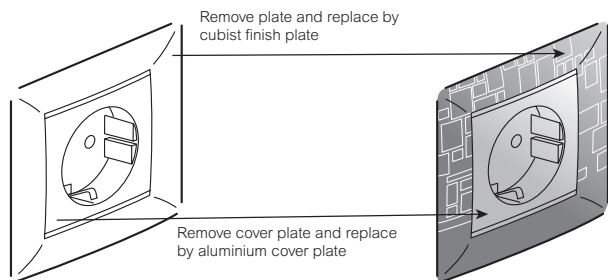





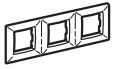
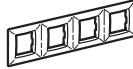
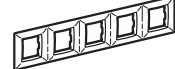

**UPGRADE YOUR CURRENT INSTALLATION**

FUNCTIONS			ALUMINIUM COVER PLATES						
			For single control	For double control	For 2P+E German standard socket	For 2P+E German standard shuttered	For 2P+E French standard socket	For single R45 socket	For single TV socket
One-way switch 10 AX		7 744 01 7 743 01	7 702 51	-	-	-	-	-	-
Two-way switch 10 AX		7 744 06 7 743 06	7 702 51	-	-	-	-	-	-
Push-button 10 A		7 744 11 7 743 11	7 702 51	-	-	-	-	-	-
Two-way switch 16 AX		7 742 05 7 741 05	7 702 51	-	-	-	-	-	-
2-gang two-way switch 10 AX		7 744 08 7 743 08	-	7 702 52	-	-	-	-	-
Double changeover push-button 10 A		7 742 18 7 741 18	-	7 702 52	-	-	-	-	-
2P+E 16 A German standard Screw terminals		7 744 20 7 743 20	-	-	7 702 53	7 702 57	-	-	-
2P+E 16 A German standard Screw terminals with shutters		7 744 21 7 743 21	-	-	-	7 702 57	-	-	-
2P+E 16 A French standard Screw terminals		7 743 96 7 743 98	-	-	-	-	7 702 54	-	-
RJ 45 UTP Cat. 5e		7 742 30 7 741 30 7 742 38 7 741 38	-	-	-	-	-	7 702 55	-
RJ 45 UTP Cat. 6		7 742 46 7 741 46 7 742 42 7 741 42	-	-	-	-	-	7 702 55	-
TV star socket - Att ≤ 1,5 dB		7 744 29 7 743 29	-	-	-	-	-	-	7 702 56
TV terminal socket - Att ≤ 10 dB		7 744 30 7 743 30	-	-	-	-	-	-	7 702 56
TV throughwiring - Att ≤ 14 dB		7 744 31 7 743 31	-	-	-	-	-	-	7 702 56





# Valena™

## plate selection charts

PLATES	Horizontal			Vertical		Horizontal and vertical <sup>1</sup>	
	1 gang	2 gang	3 gang	2 gang	3 gang	4 gang	5 gang
							
Ivory 	7 743 51	7 743 52	7 743 53	7 743 56	7 743 57	7 743 54	7 743 55
Ivory Gold 	7 741 51	7 741 52	7 741 53	7 741 56	7 741 57	7 741 54	7 741 55
Matt Gold <b>N</b> 	7 703 01	7 703 02	7 703 03	7 703 06	7 703 07	7 703 04	7 703 05
Tanned Wood <b>N</b> 	7 703 11	7 703 12	7 703 13	7 703 16	7 703 17	7 703 14	7 703 15
Baroque Matt Gold <b>N</b> 	7 700 20	-	-	-	-	-	-
White 	7 744 51	7 744 52	7 744 53	7 744 56	7 744 57	7 744 54	7 744 55
White / Crystal 	7 744 61	7 744 62	7 744 63	7 744 66	7 744 67	7 744 64	7 744 65
White / Silver 	7 704 91	7 704 92	7 704 93	7 704 96	7 704 97	7 704 94	7 704 95
Light Pearl <b>N</b> 	7 704 71	7 704 72	7 704 73	7 704 76	7 704 77	7 704 74	7 704 75
"Pied de Poule" <b>N</b> 	7 704 20	-	-	-	-	-	-
Aluminium 	7 701 51	7 701 52	7 701 53	7 701 56	7 701 57	7 701 54	7 701 55
Aluminium Silver 	7 703 51	7 703 52	7 703 53	7 703 56	7 703 57	7 703 54	7 703 55
Dark Wood Silver 	7 703 71	7 703 72	7 703 73	7 703 76	7 703 77	7 703 74	7 703 75
Black Silver 	7 703 91	7 703 92	7 703 93	7 703 96	7 703 97	7 703 94	7 703 95
Brushed Alu <b>N</b> 	7 703 31	7 703 32	7 703 33	7 703 36	7 703 37	7 703 34	7 703 35
Cubist Alu <b>N</b> 	7 703 41	7 703 42	7 703 43	7 703 46	7 703 47	7 703 44	7 703 45

1: Can be transformed into vertical or horizontal plate by rotation of internal trim

RETROUVEZ-NOUS AUSSI SUR

-  [www.legrand.com](http://www.legrand.com)
-  [twitter.com/legrand\\_news](https://twitter.com/legrand_news)
-  [www.youtube.com/user/legrand](http://www.youtube.com/user/legrand)
-  [www.facebook.com/Legrand](http://www.facebook.com/Legrand)

EXB14006

QR Code



LEGRAND SNC  
snc au capital de 6 200 000 €  
RCS Limoges 389 290 586

**Siège social  
et Direction Export**

128, av. du Maréchal-de-Lattre-de-Tassigny  
87045 Limoges Cedex - France  
☎ : + 33 5 55 06 87 87  
Fax: + 33 5 55 06 74 55  
e-mail: [direction-export.limoges@legrand.fr](mailto:direction-export.limoges@legrand.fr)